

Power Output Ratings		50 Hz / 400 V	
Standby Power (ESP)	kVA	275	
	kW	220	
Prime Power (PRP)	kVA	250	
	kW	200	

Standby Power (ESP)			
Manufacturer		PERKINS	
Model		1306A-E87TAG6	
No of Cylinder / Configuration		6 - INLINE	
Displacement	lt	8,7	
Bore / Stroke	mm	116,6 / 135,9	
Compression Ratio		16,9:1	
Aspiration		Turbocharged and Air-to-Air Charged Cooled	
Governor Type		ELECTRONIC/ECM	
Cooling System		WATER	
Coolant Capacity	lt	24,2	
Lubrication Oil Capacity	lt	28,3	
Electrical System	VDC	24	
Speed / Frequency		1500 rpm / 50 Hz	
Engine Gross Power	kWm	250	
Fuel Consumption	lt/h	110 %	59
		100 %	54
		75 %	43
		50 %	31
Exhaust Outlet Temperature	°C	579	
Exhaust Gas Flow	kg/s	0,32	
Combustion Air Flow	kg/s	0,31	
Cooling Air Flow	m³/min	494	

Alternator		
Manufacturer		STAMFORD
Model		HCI444C
No of Phase		3
Power Factor		0,8
No of Bearing		SINGLE
No of Poles		4
No of Leads		12
Voltage Regulation (Steady State)		± %1
Insulation Class		H
Degree of Protection		IP 23
Excitation System		AVR (Automatic Voltage Regulator), Brushless
Connection Type		STAR
Total Harmonic Content (No Load)		< %2
Frequency	Hz	50
Voltage Output	VAC	230 / 400
Rated Power (Standby)	kVA	275
Efficiency	%	92,2

	W x L x H (mm)	Weight (kg)	Fuel Tank (lt)	Noise dB(A)
Canopied	1230 x 3880 x 1900	2600	330	72
Open Skid	1200 x 2700 x 1800	2020	330	TBA



Standby Power

Standby power is defined as the maximum power available during a variable electrical power sequence, under the stated operating conditions, for which a generating set is capable of delivering in the event of a utility power outage or under test conditions for up to 500 hours of operation per year under average of 70% load. Overloading is not permissible.

Prime Power

Prime power is defined as being the maximum power which a generating set is capable of delivering continuously whilst supplying a variable electrical load. Average load should be 70%. The generator can be overloaded 10% for 1 hour per 12 hours.

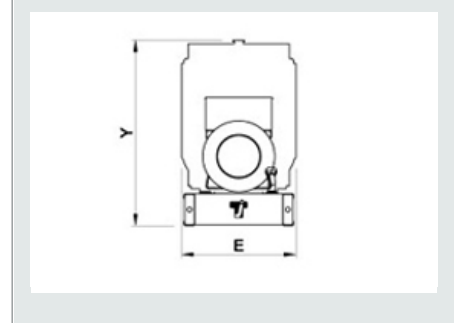
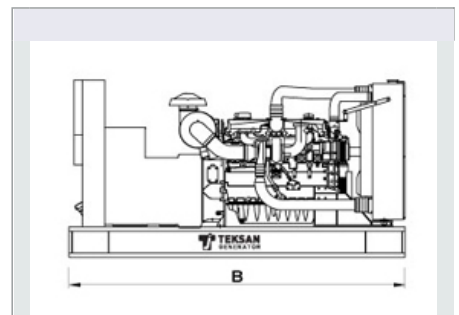

- Technical information and values are according to ISO8528, ISO3046, NEMA MG-1.22, IEC 60034-1, BS 4999-5000, VDE 0530 standards.
- Producing with ISO9001, ISO14001, OHSAS18001, TSE, CE standards.
- All information given in this leaflet is intended for general purposes only. Due to a policy continuous improvement Teksan reserves the right to amend details and specifications without notice and all information given is subject to the Teksan's current condition of sales.

TBA: To Be Ask

TBD: To Be Determined

NA: Not Available

N/A: Not Applicable

TTD275PE5S0713-EN

www.teksangenerator.com

